

Rev	Change	Date	Int.
A	Drawing created, material and tolerance table added	03-05-10	BB

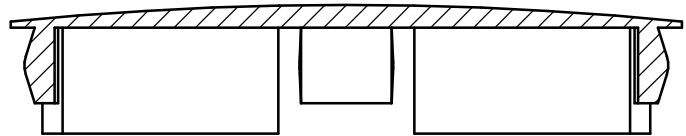

SECTION A-A
2:1

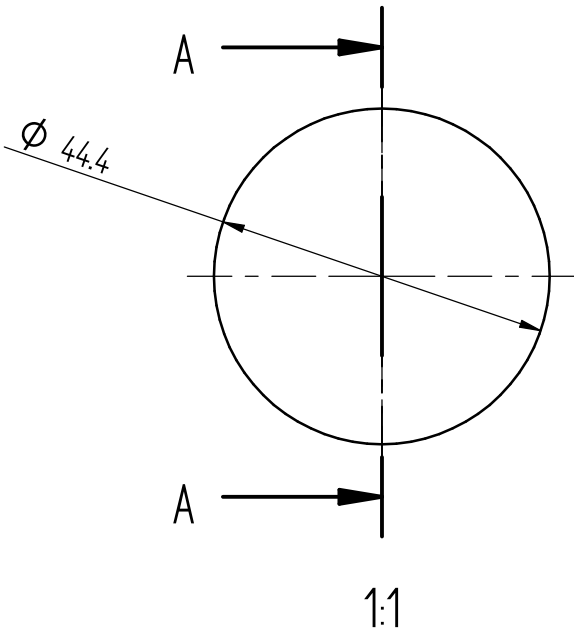
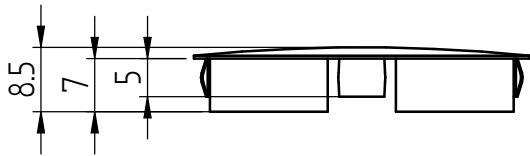
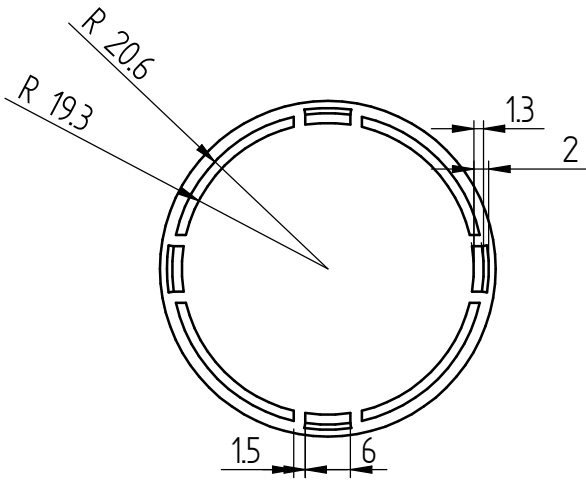
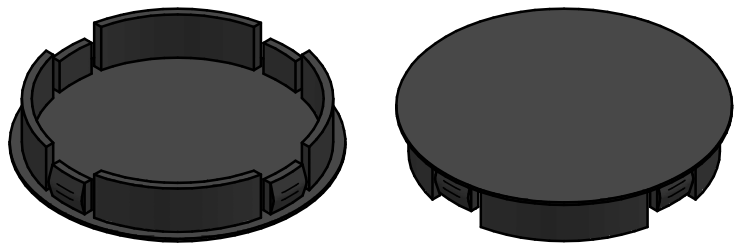

TOLERANCES PR ISO 2768

Designation	Description	0,5-3	3-6	6-30	30-120	120-400	400-1000	1000-2000	2000-4000	X°
f	fine	± 0,05	± 0,05	± 0,1	± 0,15	± 0,2	± 0,3	± 0,5	--	± 0,5°
m	medium	± 0,1	± 0,1	± 0,2	± 0,3	± 0,5	± 0,8	± 1,2	± 2,0	± 1,0°

Material PC-ABS C2100	Description SP2 End sleeve SP2 Slutbøsning	Product Line Weight 0,002 kg	Version A	Size: A4 Drawn Checked	Name BB	Date 30-09-2013
 ergonomic solutions		COPYRIGHT © ERGONOMIC SOLUTIONS 2010 www.ergonomic-solutions.net Unless otherwise specified tolerances according to ISO 2768-m All dimensions are in millimeters				

SOLID EDGE RESELLER COPY

Description SP2 End sleeve SP2 Slutbøsning		Product Line	Weight 0,002 kg	Version A
 ergonomic solutions	COPYRIGHT © ERGONOMIC SOLUTIONS 2010 www.ergonomic-solutions.net <small>Unless otherwise specified tolerances according to ISO 2768-m All dimensions are in millimeters</small>	Size: A4	Name	Date
		Drawn	BB	30-09-2013
		Checked		
		Drawing No		
		SP2-P22104-02		

SOLID EDGE RESELLER COPY